

Civil-Military Cooperation In the Kandahar PRT

21 Jul 05 – 14 Feb 06

Major S.F. King
Senior CIMIC Officer

Roto 0



PRT Mission

The CA PRT, in support of TF BAYONET (173rd Airborne Brigade) will conduct operations to enable Security Sector Reform (SSR) and reconstruction efforts in order to assist the Government of Afghanistan (GOA) to extend its authority and facilitate the development of a stable and secure environment in the KANDAHAR Province AOO.



Priorities

- Support to NAPCE (Elections)
- Prepare Civil-Military momentum (SSR)
- Implement SSR
- Enable Other Governmental Department activities





CFC-A Counter-Insurgency Strategy

**Center of Gravity:
The Afghan People**

Interagency Cooperation = Unity of Purpose

**Defeat
Terrorism
&
Deny
Sanctuary**

**Enable
Afghan
Security
Structure**

**Sustain
Area
Ownership**

**Enable
Reconstruction
and
Good
Governance**

**Engage
Regional
States**

Information Operations

In Kandahar, Tribal issues affect everything !

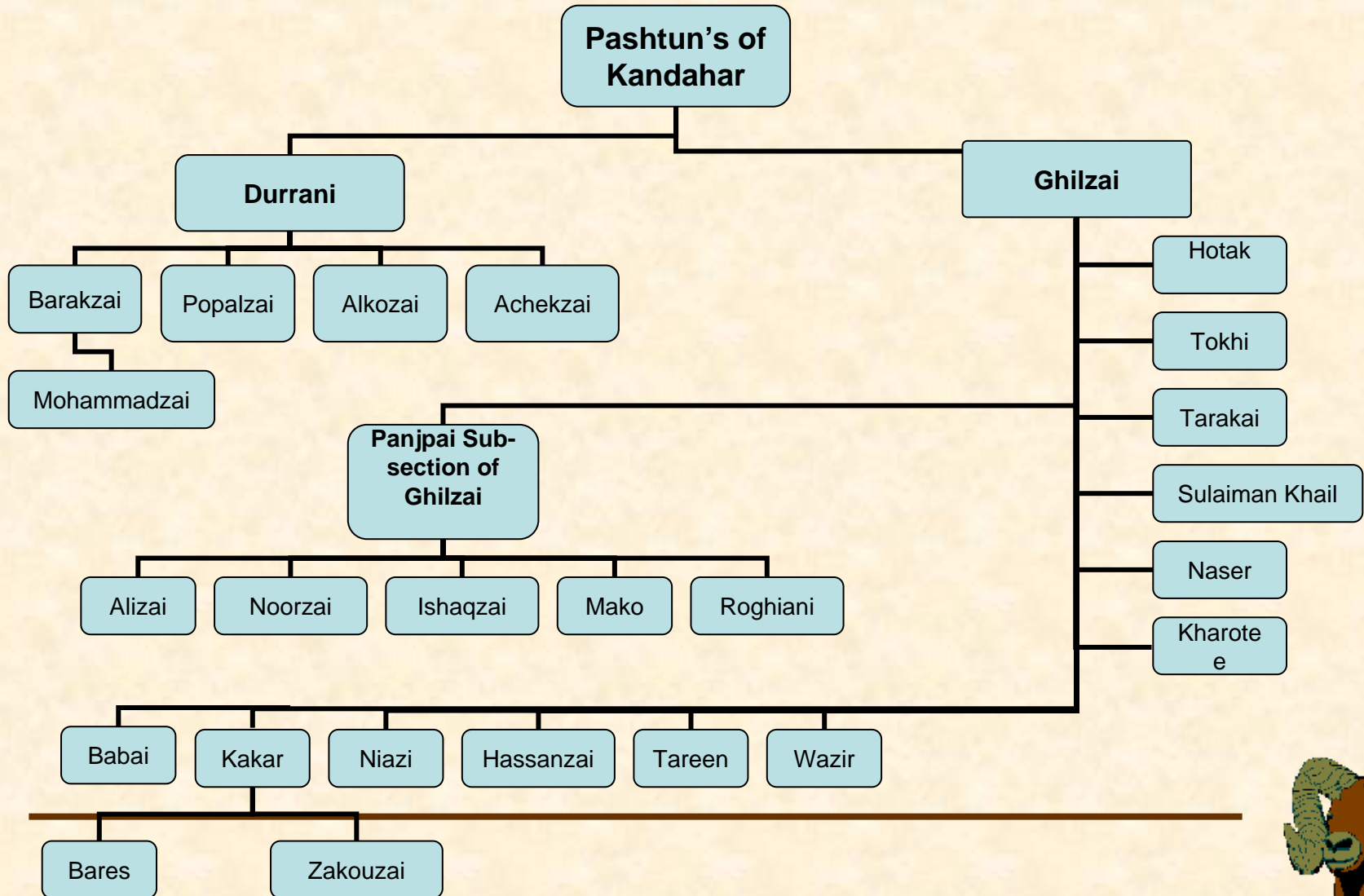

Kandahar Reality



Threats

- Sanctuary; family and tribal ties
- Isolated population
- Poor provincial and district leaders
- IED, indirect fire and direct fire threat

- Sanctuary; family and tribal ties
- Isolated population
- Developing leaders
- IED, indirect fire and direct fire threat

- Infiltration along traditional drug routes
- Stage in remote areas
- Weak provincial and district leadership
- Isolated population

- Multiple infiltration routes
- Facilitation network
- IED cells
- Weak district leaders
- Isolated population

- Limited sanctuary
- Ineffective district leaders
- Ability to impact city

- Hwy 4 infiltration
- Crime / tribal

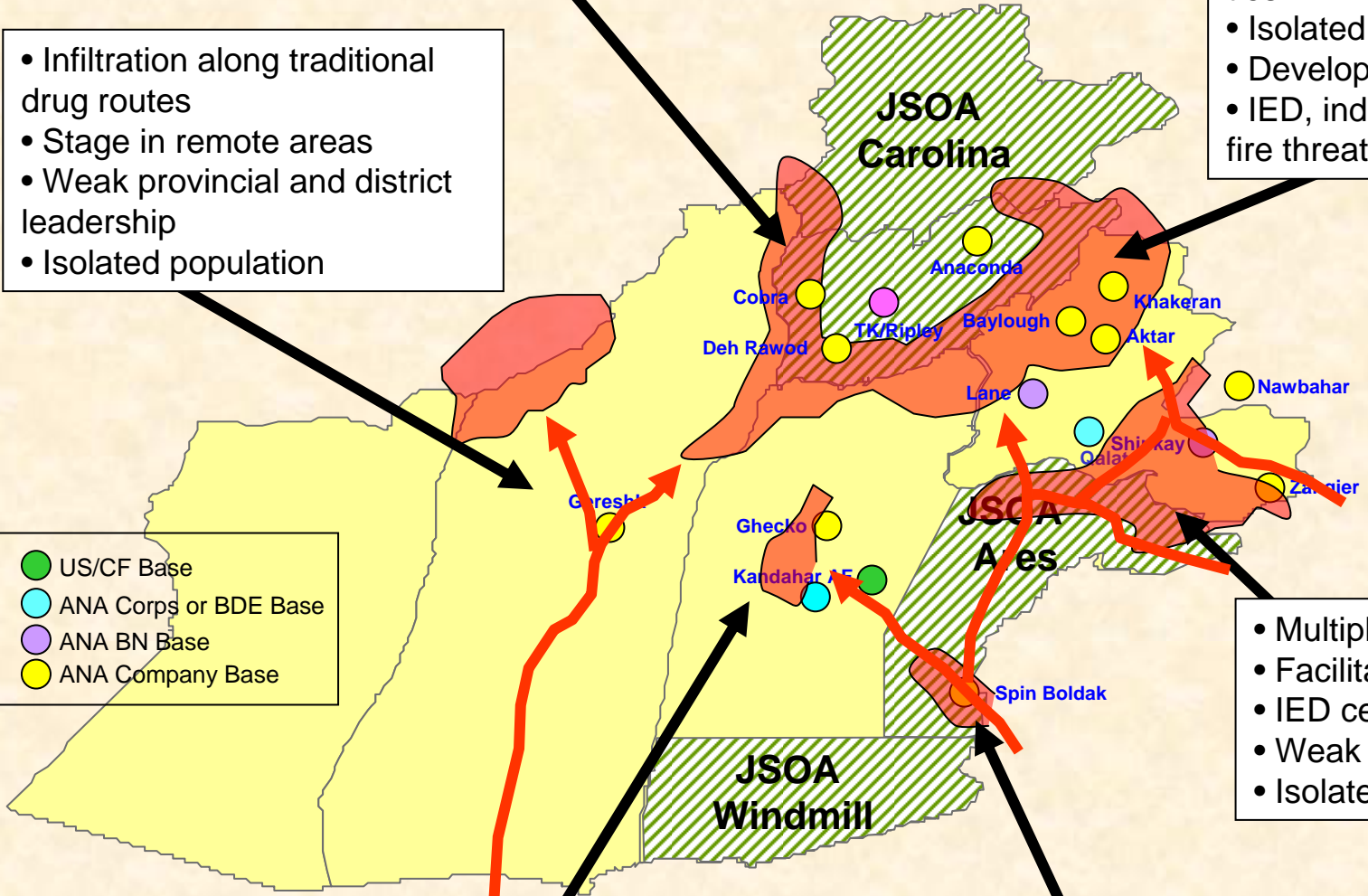





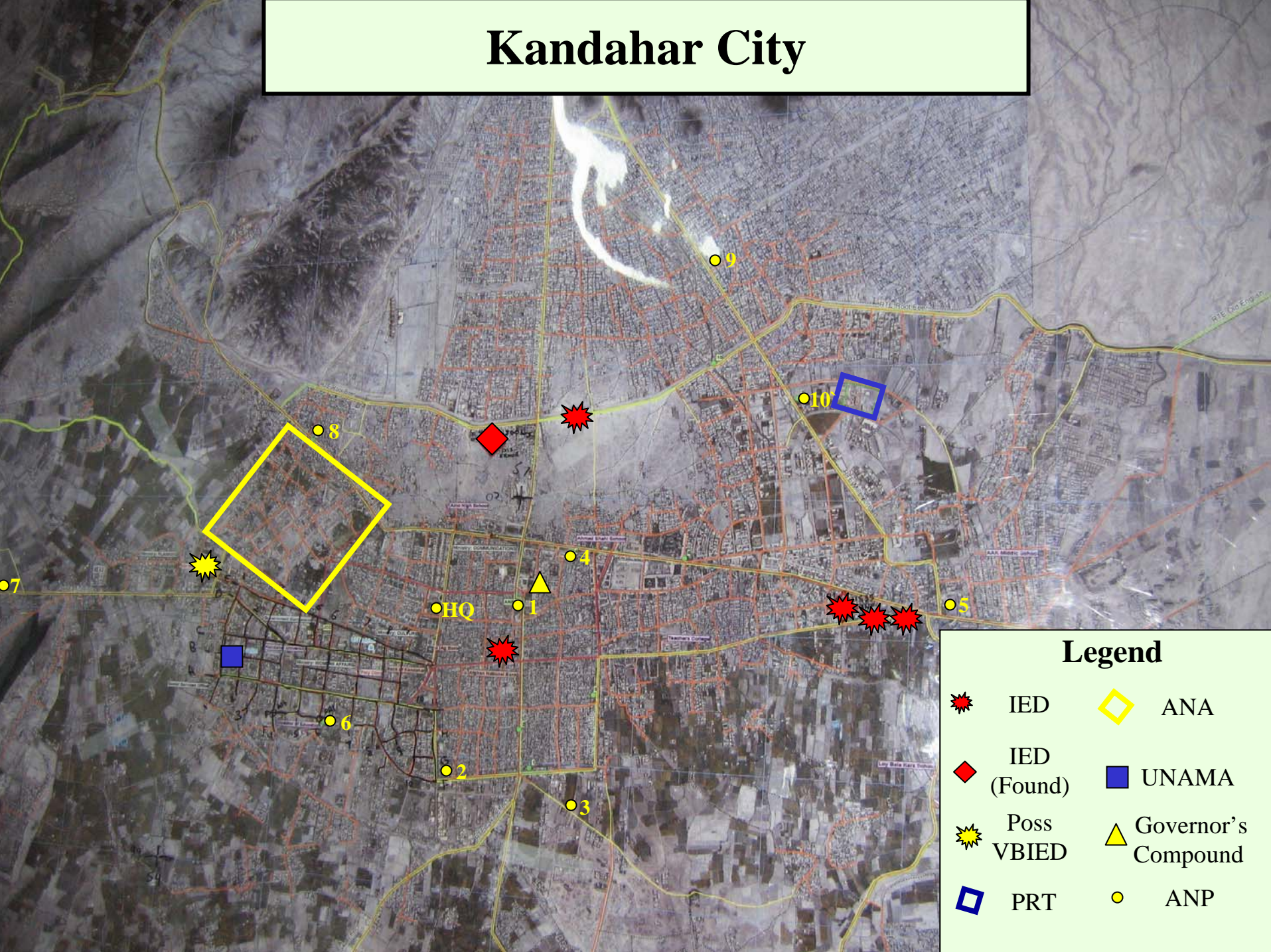



- US/CF Base
- ANA Corps or BDE Base
- ANA BN Base
- ANA Company Base

Kandahar City



Legend

- | | | | |
|---|-------------|---|---------------------|
|  | IED |  | ANA |
|  | IED (Found) |  | UNAMA |
|  | Poss VBIED |  | Governor's Compound |
|  | PRT |  | ANP |

PRT Organization

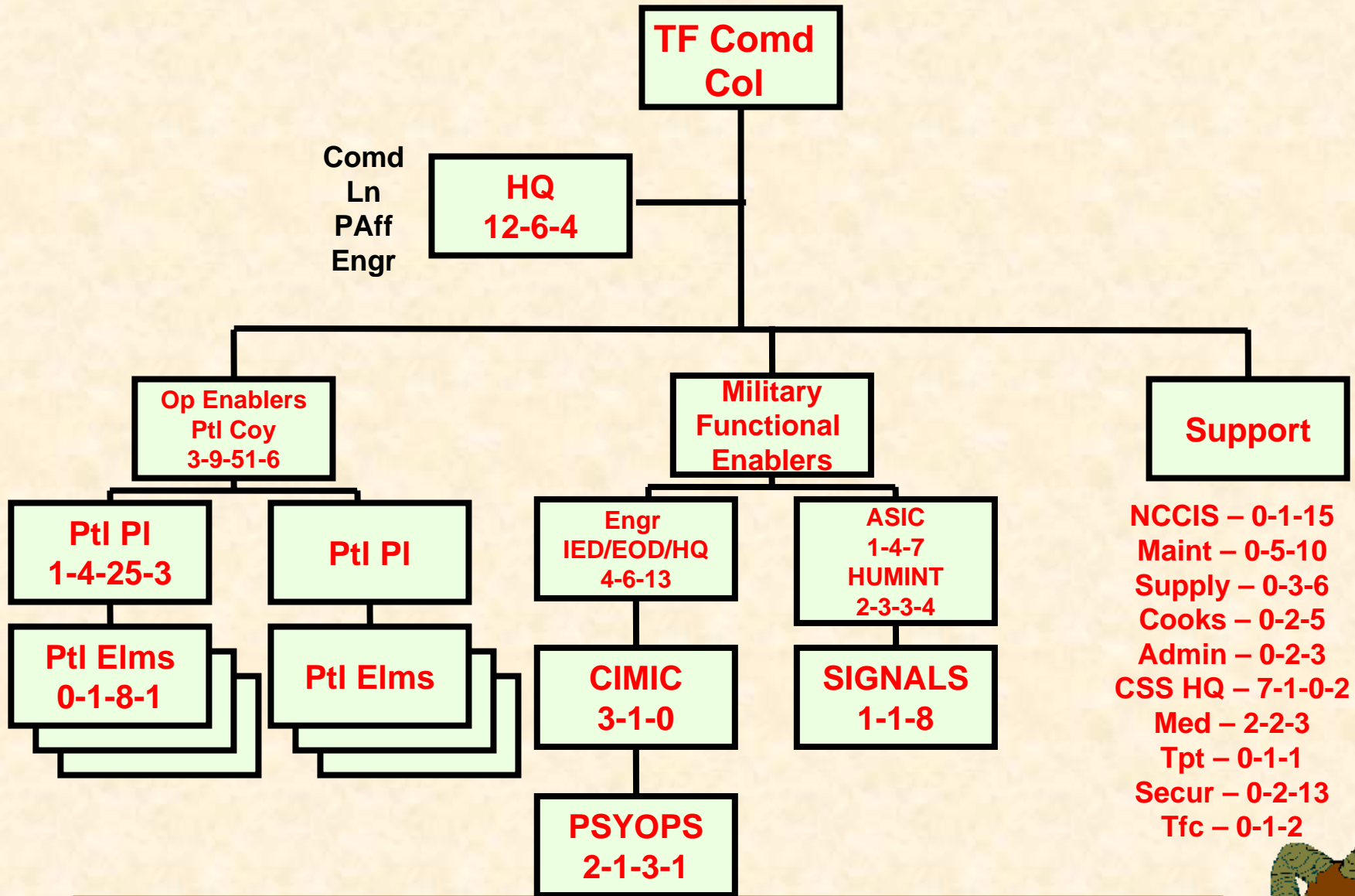

Capabilities

- Robust FORCE PRO element
 - 7x 3-car patrols
 - Each patrol had integral Signals, Medical, and Engineer Specialists
 - Each patrol has TACSAT capability
 - Tasks: KAF Convoy Escort, QRF, Camp Security x 2, and 3 x Ptls sustained (independent of BIGHORN 6)
- Robust Engineering Capability
 - 1x Field Section
 - 2x Recce Detachments
 - 1x IEDD Detachment (Undeclared)



Capabilities

- Robust Force Multipliers
- Info Ops Campaign Integration Consisting of
 - 1x CIMIC Detachment (4x Independent CIMIC Officers)
 - With Civil Affairs Projects Team detachment
 - 1x ASIC
 - GEO production capability
 - Analysis and Collation Capability
 - 2x HUMINT Teams (THT) (ltd capability)
 - 1x PSYOPS Det
- Integral Signals to include secure TACSAT, VHF, UHF, and National Rear Link
- National 3D/International DIME tm:
 - FAC x 2, CIDA x 1, RCMP x 2, USAID x 1, DFID x 1



Patrol in Action



CIMIC on Patrol



Patrol Coy Points

- **Demanding TMST**
 - This is a Sect Comd's mission. Due to the nature of PRT operations, Sect Comd's must make difficult decisions in the absence of higher direction or with incomplete information
- **Troops to Task**
 - With the shift from security to more capacity development and governance ops, the ability to send patrols out is critical. Resourcing of the PRT to task must take this into account
- **Info Ops**
 - All PRT personnel are conducting Info Ops and HUMINT collection at all times. All personnel must be cognizant of this fact. Complete understanding of the Comd's intent is critical



A Dangerous Environment



A Dangerous Environment



PRT CIMIC OVERVIEW



CIMIC Role in PRT

- Civil-military liaison,
- Coordination of Civil Military Operations in Kandahar Province,
- Provide limited project support, and
- Support the political and development members of the “All of government” team.



PRT CIMIC ELEMENT

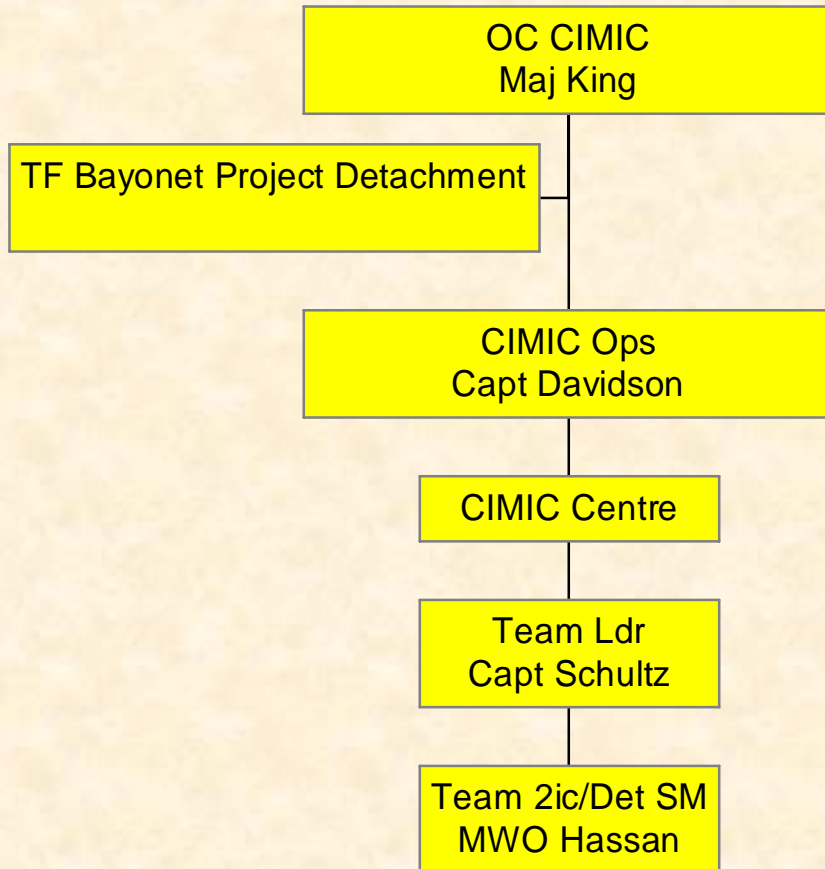

CIMIC Duties

CMCC- CIMIC Det HQ

- Comd of CIMIC elm and provide advice to PRT Comd
- Ln with Provincial and District government officials
- Ln with IO's (UN agencies, etc)
- Coord all Provincial Civil Military Operations
- Integrate with PRT IO Campaign
- PRT Rep for ANBP (DIAG and Ammo & Tech)
- Support PRT "All of Government" team members

CIMIC Centre - TST

- Conduct tactical CIMIC
- Ln with NGO's in the AO
- Establish and run a CIMIC Centre at the PRT
- Plan and manage PRT CIMIC projects
- Support PRT "All of Government" team members



Capabilities and Partners

- CIMIC Detachment
- CIDA – Michael Callan
- FAC – Erin Dorgan
- DFID (UK) – Matthijs Toot
- CERP (US Civil Affairs funds)
- USAID – Ashley Abbott
- Others (i.e. JICA)



CIMIC Lines of Activity

- Strengthen Government of Afghanistan,
- Facilitate reconstruction efforts – target sectoral “systems”,
- Identify and help eliminate sources of local conflict, and
- Support and facilitate the extension of National Programs.



Governor



Directors



IO/ NGO



Districts

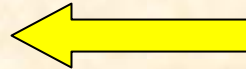

People

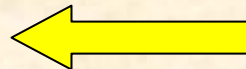

Engage at all levels

– Simultaneously
and in depth



Governor

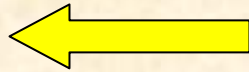

Directors



IO/ NGO



Districts

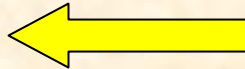

People

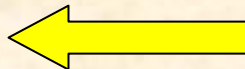

Institution building-
ANSF/ Higher Education
Large scale Provincial
Projects, strengthen
“systems”, National
programs

Coordinate, Facilitate
and address their
Concerns (NGO Roll-out)

Work locally to strengthen
government, facilitate
“local” ownership of issues
and engage “key nodes”-
hidden leadership



Girl's School Opening



AREAS OF INSTABILITY

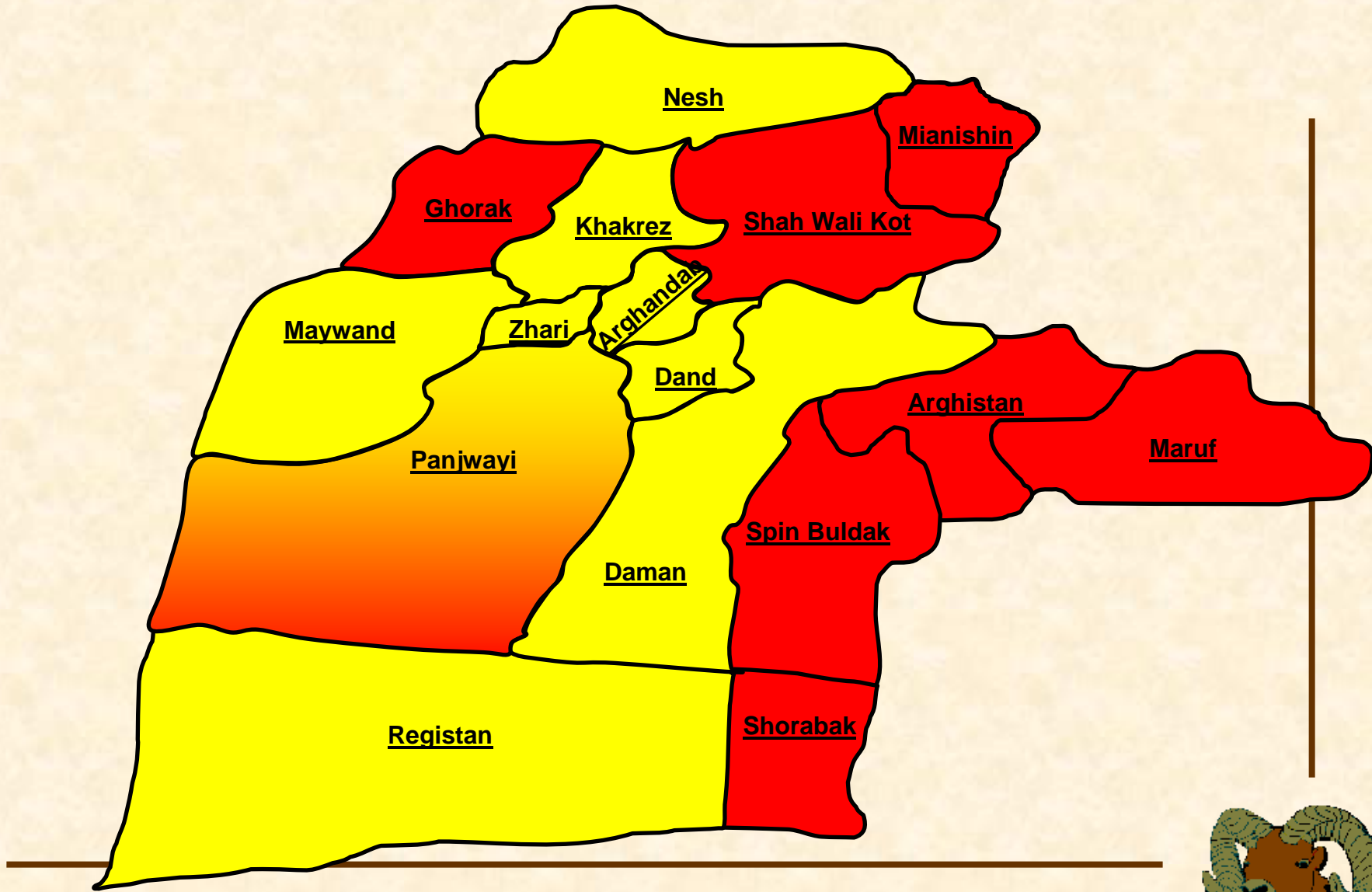

CIMIC Campaign Plan – Offensive “non-kinetics”

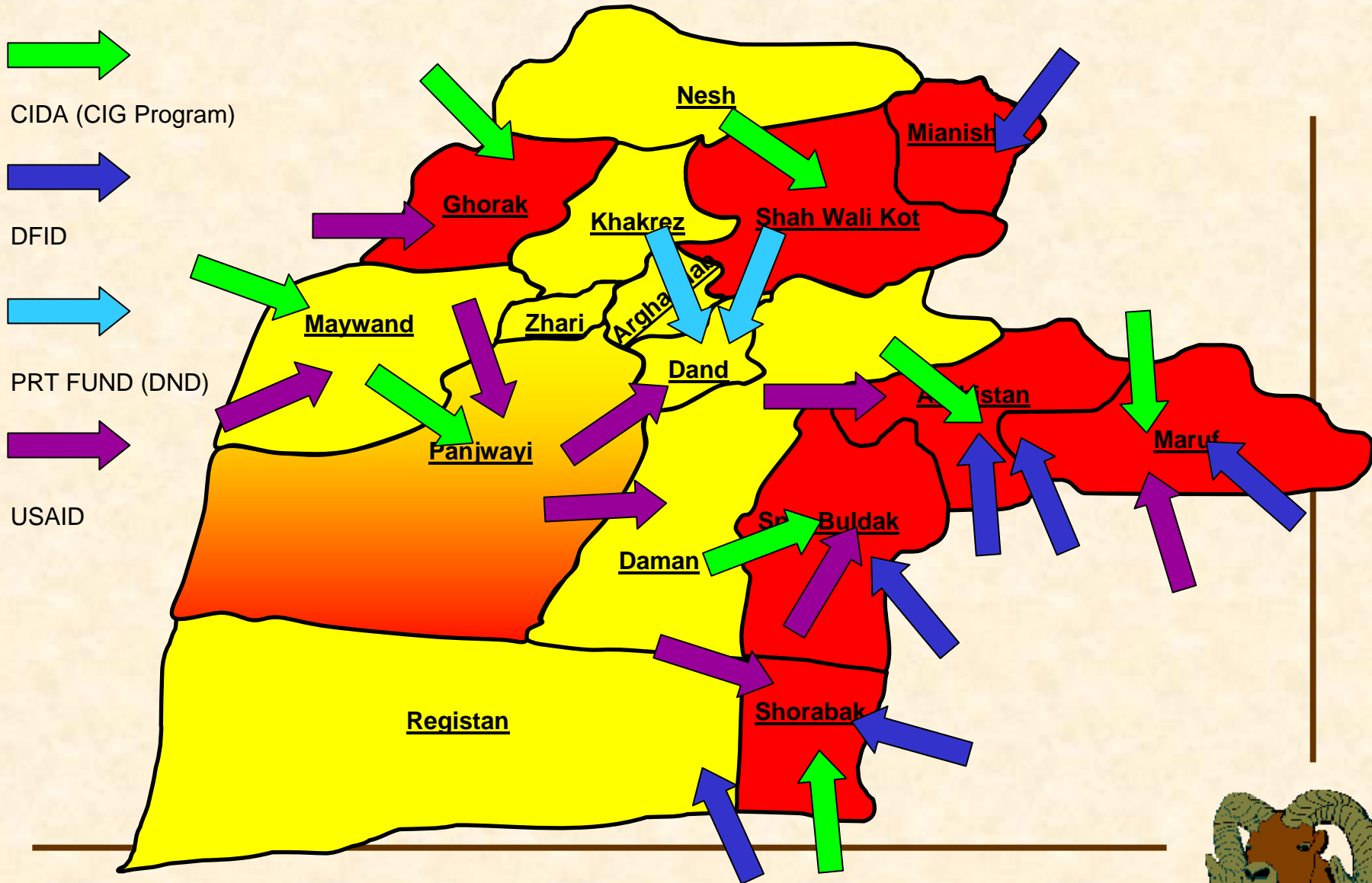

Operational Overview



CIMIC Operational Review

Commander's Contingency Fund (CCF)

- \$1.162 M
- ANP Infrastructure, MRO, ASP, Gov LAN, Veh purchase

CERP (TF Gun Devils / CAPT)

- \$ 1.792 M USD committed
- Water/wells, Micro-roads, tractors, KAF air terminal, Gov't Vehs

Kandahar University

- Medical skills program
- Engineer mentoring program
- Medical School donations
- Canadian University engagement



CIMIC Operational Review

Afghan New Beginnings (ANBP)

- Disbandment of Illegally Armed Groups (DIAG)
 - Security and development committees
- Ammunition and Technical
 - New ACP/ASP at Camp Sherzai

Light Up the World

- Solid-state lighting
- Solar powered
- \$ 50 K Pilot Project



Confidence in Government



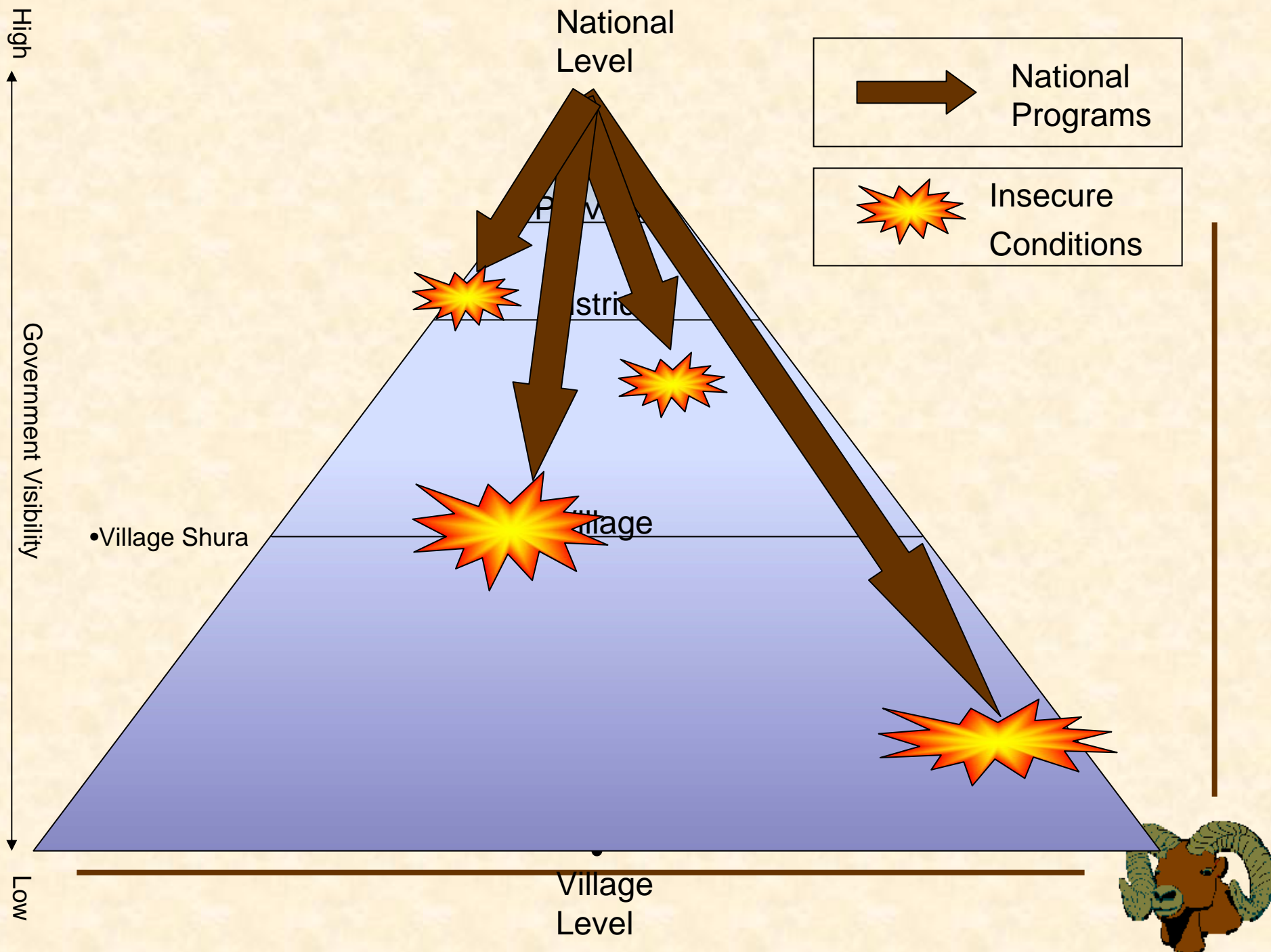

Questions?

